

SAC3050QP3

GaAs MMIC Low Noise Amplifier
0.02~6GHz

Rev 1.1

Features

- Frequency: 0.02~6GHz
- Gain: 20dB
- Noise Figure: 1.0dB
- Power Supply: +5V@68mA
- Package Size: 3mmx3mmx0.75mm

Typical Applications

- Microwave radio
- Telecommunication
- Weather radar
- Optical communication
- Test instrumentation
- SatCom
- VSAT
- Military and Aerospace

General Description

SAC3050QP3 is a GaAs MMIC Low Noise Amplifier which operates between 0.02 to 6GHz. The amplifier can provide 20dB gain, 19dBm Output P_{1dB}, 1.0dB noise figure from a 68mA supply current.

The device assembled in a 3x3mm plastic QFN package

Functional Diagram

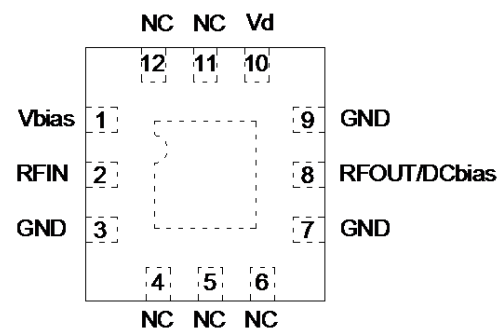

Electrical Performance (T_A=25°C, V_D= +5V, I_D=68mA, Z_O=50Ω)

Parameter	Min.	Typ.	Max.	Units
Frequency Range	0.02~6			GHz
Gain	18.5	20	22.5	dB
Gain Flatness	—	2	3	dB
Input/Output VSWR	—	1.5	1.9	:1
Noise Figure	—	1.0	1.5	dB
Reverse Isolation	—	-25	—	dB
Output Power for 1 dB Compression (OP _{1dB})	17.5	19	—	dBm
Output Third Order Intercept (OIP ₃)	30	33	—	dBm
Output Third Order Intercept (OIP ₂)	—	48	—	dBm
Supply Current(I _D)	—	68	—	mA

Absolute Maximum Ratings

Maximum Input Power	+18dBm	Operating Temperature	-55°C~+85°C
Channel temperature	+150°C	Storage Temperature	-65°C~+150°C

SuperApex Corporation

Address: 111 Barclay Boulevard, Ste. 211, Lincolnshire, IL 60069,USA
 Tel:1-847-573-9866, 1-847-505-8319
 E-mail: sales@superapexco.com
 Website: www.superapexco.com

SAC3050QP3

GaAs MMIC Low Noise Amplifier
0.02~6GHz

Rev 1.1

Typical Performance Curve

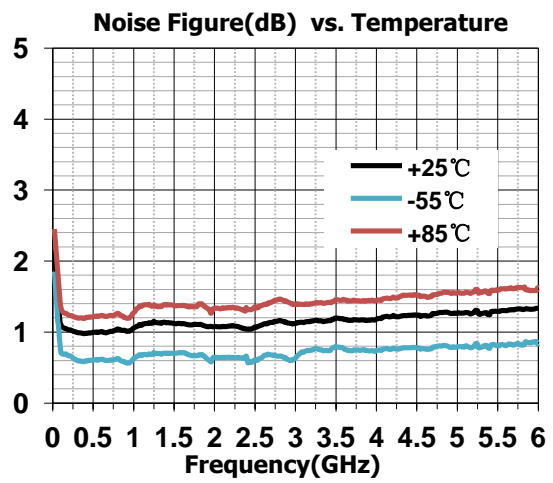
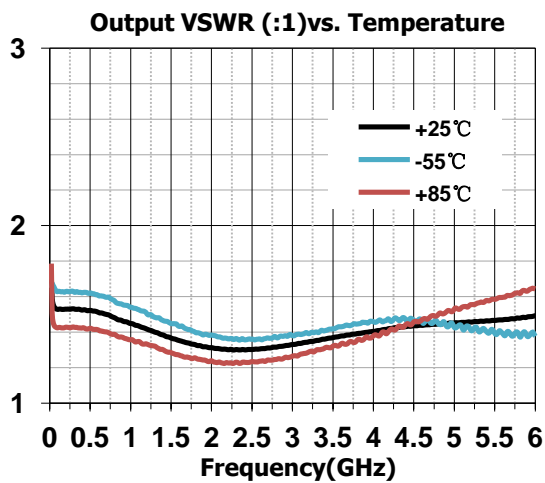
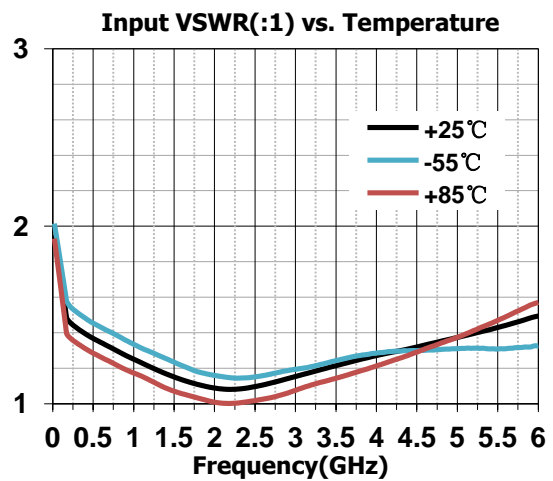
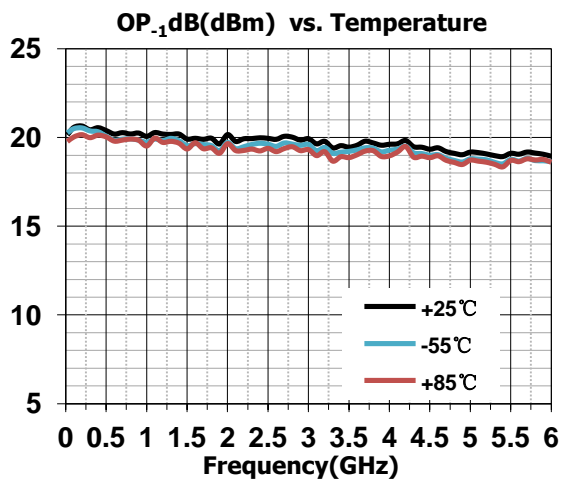
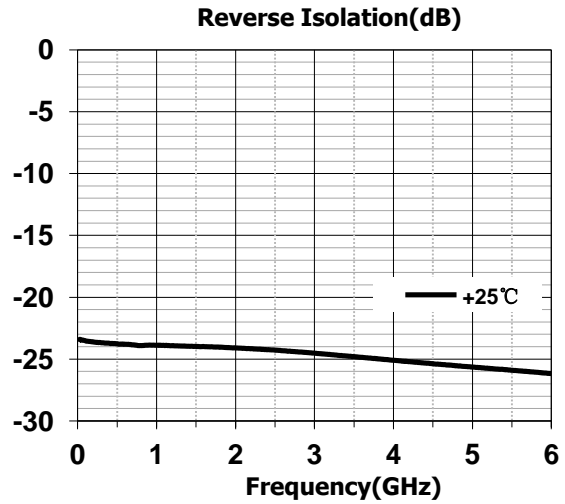
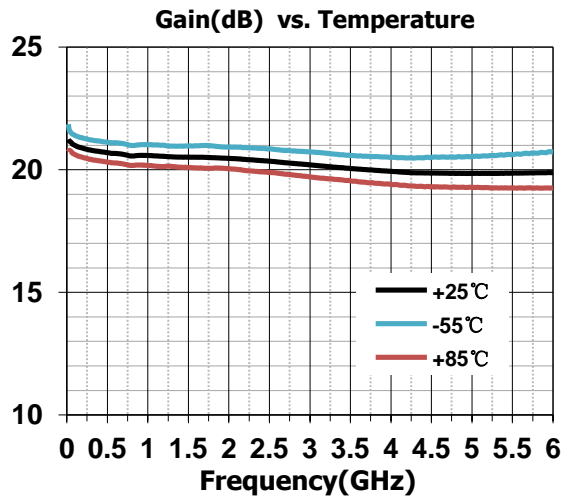

SAC3050QP3

GaAs MMIC Low Noise Amplifier
0.02~6GHz

Rev 1.1

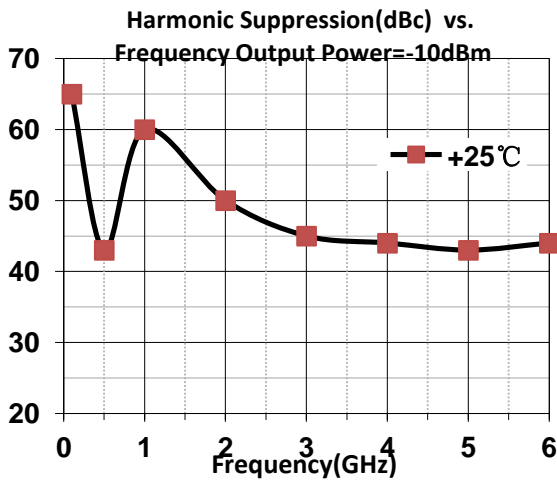
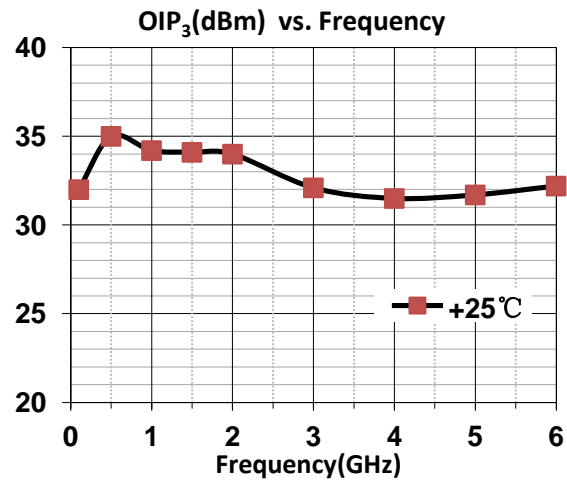
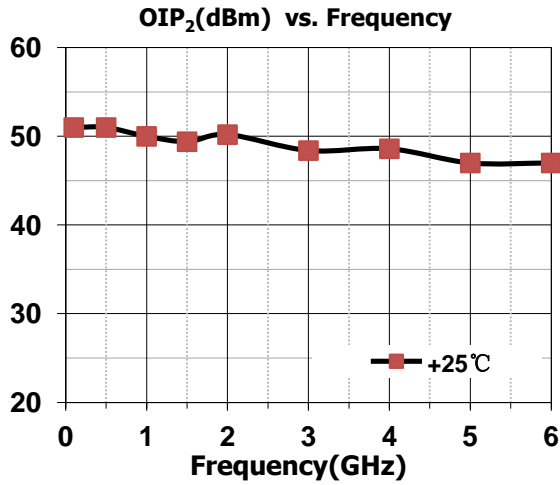

Outline Drawing (all dimensions in mm)

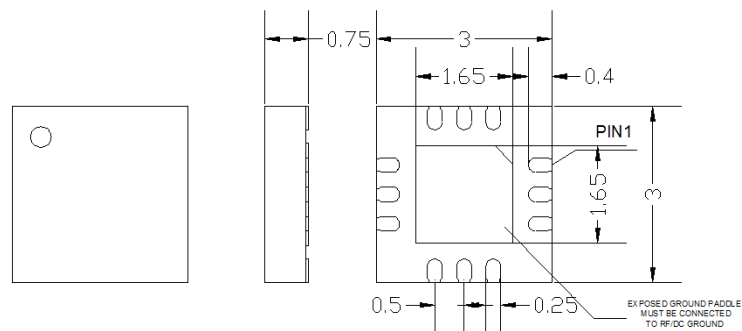

SAC3050QP3

GaAs MMIC Low Noise Amplifier
0.02~6GHz

Rev 1.1

Application Circuit Configuration

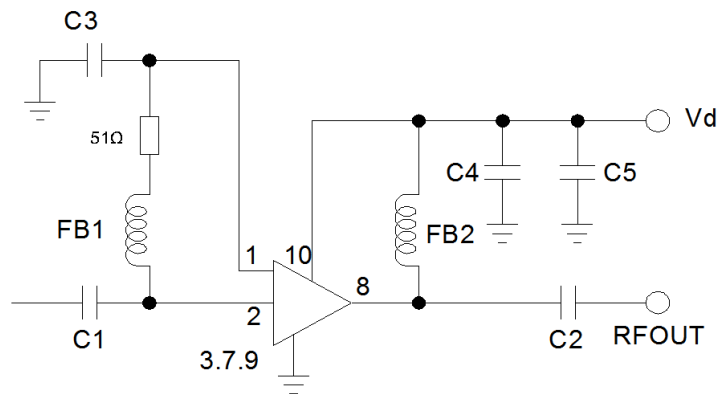

Components List

Reference Des.	Value	Part Number	Manuf.
C1,C2,C3	1000pF	GRM188R61H102KA01	MURATA
C4	100pF	GRM188R61H101KA01	MURATA
C5	10nF	GRM1857U1A103JA44	MURATA
FB1,FB2	—	MMZ1005A222ET	TDK

Attention:

1. The moisture resistant grade of products is 2A, the storage environment $\leq 30^{\circ}$ C/60% RH, The surrounding workshop Life is 4 weeks. 2. After un-packing, It is necessary to bake the parts for 6 hours in 125+/-5 degree environment before soldering.